

NO.	DESCRIPTION	MATERIAL
1	FLANGED Y	CAST IRON A126 CL.C
2	BUTTERFLY VALVE	IRON / BUNA-N SEAL
3	BODY	CAST IRON A126 CL.C
4	LINKAGE	STEEL
5	COVER	CAST IRON A126 CL.C
6	SWING BOLTS	CARBON STEEL
7	GEAR OPERATOR	IRON
8	BASKET	
	PERF. DIA.	
	MESH SIZE	
9	O-RING	BUNA-N
10	BOLT/NUT	CARBON STEEL
11	PIPE PLUG (DRAIN)	IRON
12	PIPE PLUG (VENT)	IRON
13	PIPE PLUG (GAGE)	IRON

NOTES:

1. INLET/OUTLET FLANGE PER ANSI B16.1 CLASS 125 FF FLANGE.
2. MAX. WORKING PRESS.: 200 PSI @100° F. (13.8 BAR @ 37.8° C)
3. DIMENSIONS ARE IN INCHES / (MM).
4. WEIGHT: 2650 LBS. (1202 KG.)

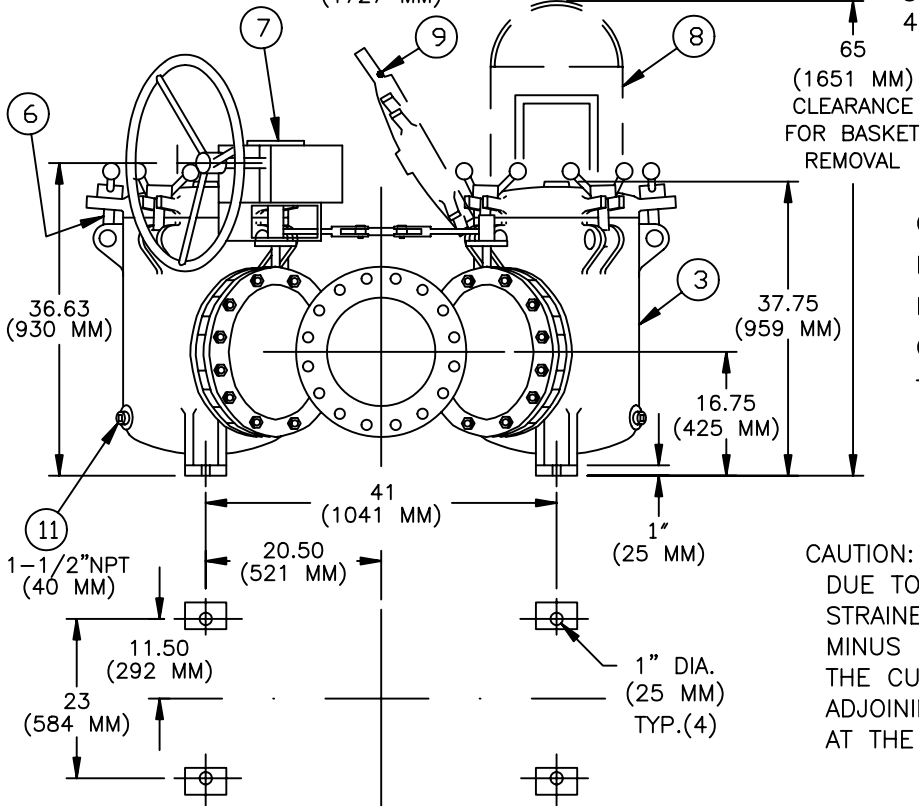

PLAN VIEW
(MOUNTING)

CUSTOMER:
P.O. NO.:
REG. NO.:
QUOTE NO.:
TAG NO.:

CAUTION:

DUE TO THE TYPE OF CONSTRUCTION OF THIS STRAINER, ALL DIMENSIONS MAY VARY PLUS OR MINUS 1.50% OF THE CHARTED FIGURES. THE CUSTOMER IS ADVISED NOT TO FABRICATE ADJOINING PIPING UNTIL RECEIPT OF THE UNIT AT THE JOB SITE.

		EATON FILTRATION, LLC 900 FAIRMOUNT AVENUE, ELIZABETH, NEW JERSEY 07207					
		NAME MODEL 50 DUPLEX STRAINER 125# FLAT FACE FLANGE SIZE 12" CAST IRON					
DRAWN	FM	DATE	3/14/94	CERT.	GJL	DATE	3/14/94
SIZE	DWG	SD052103				REV	C
A	NO						

UNAUTHORIZED USE, MANUFACTURE OR REPRODUCTION IN WHOLE OR IN PART IS PROHIBITED. DRAWING, DESIGN AND OTHER DISCLOSURES PROPERTY OF EATON FILTRATION, LLC

ELECTRONIC FILE NAME: SD052103.DWG
REF. ECR D507 DATE 11/1/05